

## GOLD PX 04-07, 08 eff.var./cap.var. 1, avfrost./defr. standard

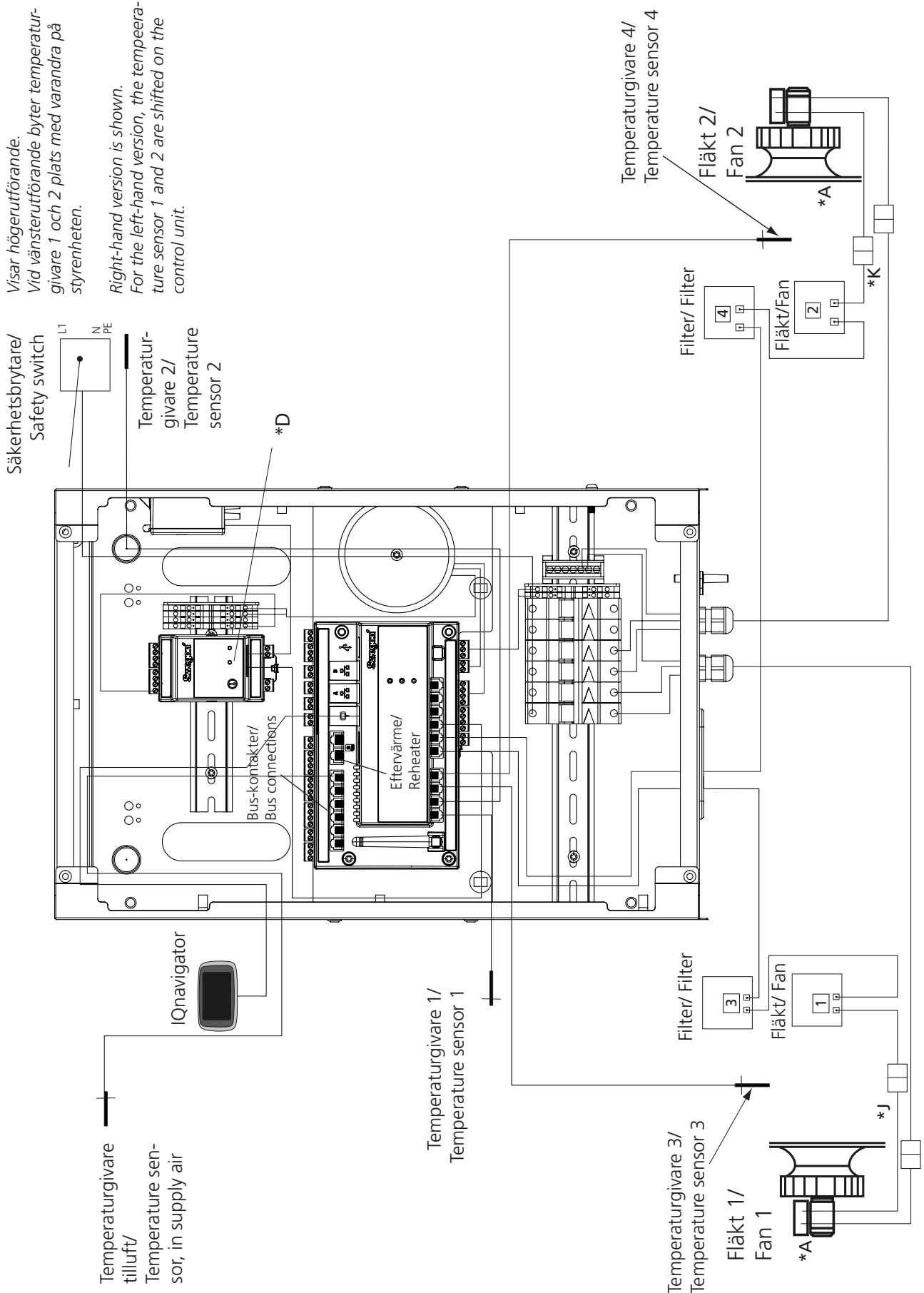

Visar högerutförande.

Vid vänsterutförande byter temperaturgivare 1 och 2 plats med varandra på styrenheten.

Right-hand version is shown.

For the left-hand version, the temperature sensor 1 and 2 are shifted on the control unit.

Säkerhetsbrytare/  
Safety switch

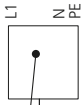

Temperaturgivare 2/  
Temperature sensor 2

\*D

Bus-kontakter/  
Bus connections

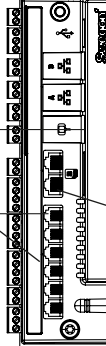

Eftervärme/  
Reheater

Temperaturgivare tilluft/  
Temperature sensor, in supply air

Temperaturgivare 1/  
Temperature sensor 1

Temperaturgivare 3/  
Temperature sensor 3

Fläkt 1/  
Fan 1

\*A

Temperaturgivare 4/  
Temperature sensor 4

Fläkt 2/  
Fan 2

\*A

Filter/ Filter

Fläkt/Fan

\*K

Filter/ Filter

Fläkt/ Fan

\*J

**GOLD PX 08 eff.var./cap.var. 2, avfrost./defr. standard**

*Visar högerutförande.  
Vid vänsterutförande byter temperaturgivare 1 och 2 plats med varandra på styrenheten.*

*Right-hand version is shown.  
For the left-hand version, the temperature sensor 1 and 2 are shifted on the control unit.*

Säkerhetsbrytare/  
huvudbrytare/  
Safety switch/  
main switch

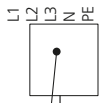

Temperaturgivare 2/  
Temperature sensor 2

\*D

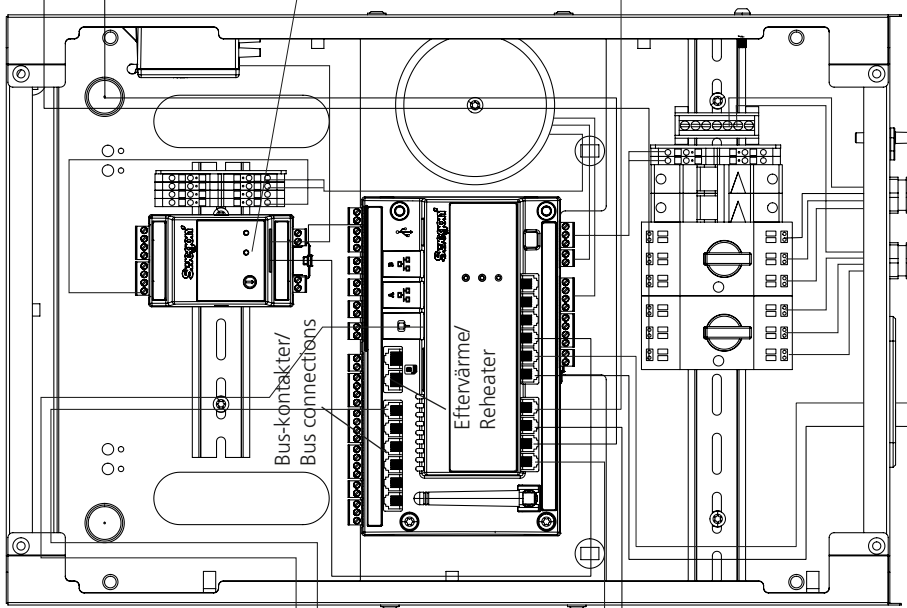

Temperaturgivare tilluft/  
Temperature sensor, in supply air

Temperaturgivare 1/  
Temperature sensor 1

Avfrostningsgivare wx/  
Defrosting sensor, heat exchanger

Temperaturgivare 4/  
Temperature sensor 4

Temperaturgivare 3/  
Temperature sensor 3

Fläkt 1/  
Fan 1

\*B

Filter/ Filter

Fläkt/ Fan

\*J

Filter/ Filter

Fläkt/ Fan

\*K

Fläkt 2/  
Fan 2

\*B

## A: GOLD RX/PX/SD 04/05, 08/11 eff.var./cap.var. 1

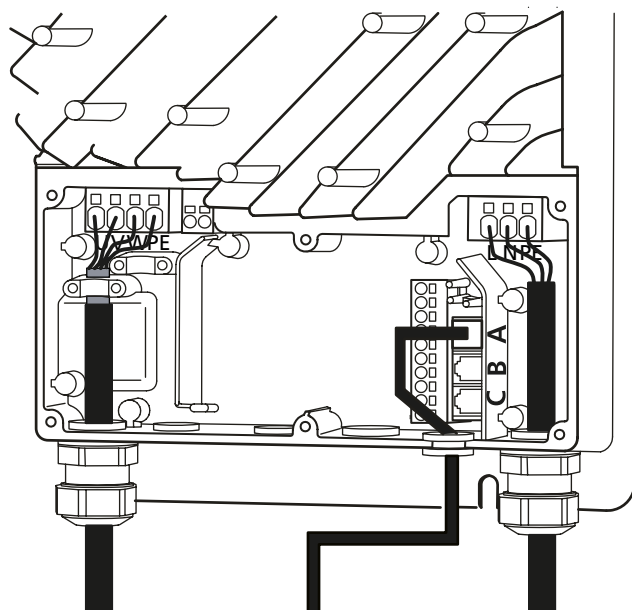

## B: GOLD RX/PX/CX/SD 08/11 eff.var./cap.var. 2, 12-120

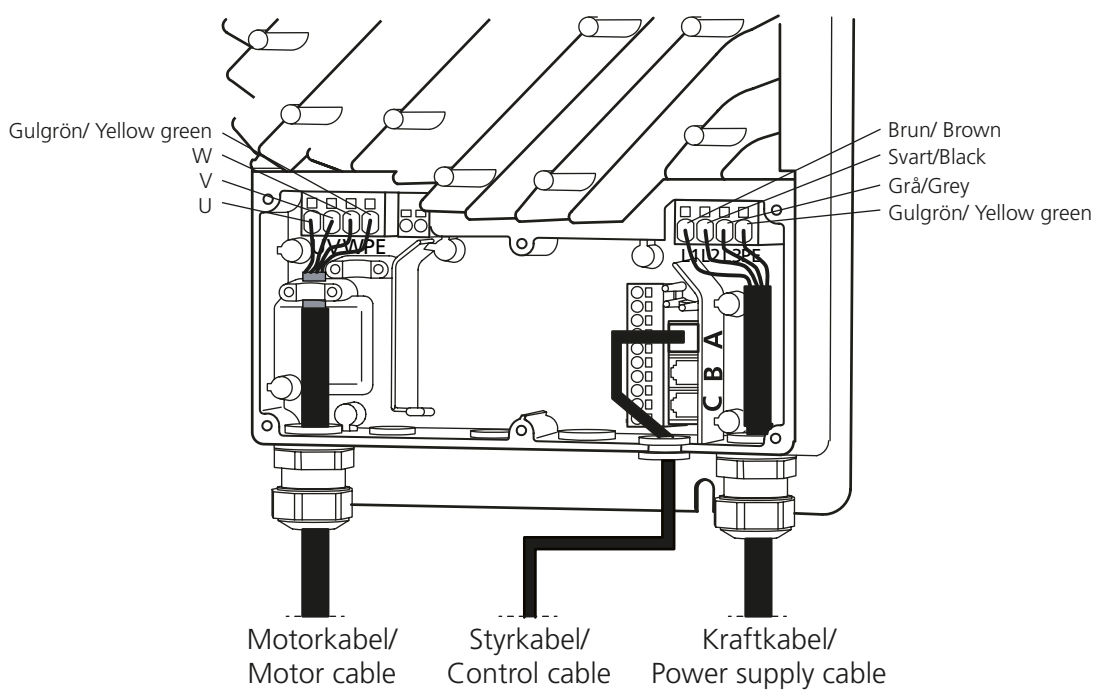

## D: GOLD PX 04-30

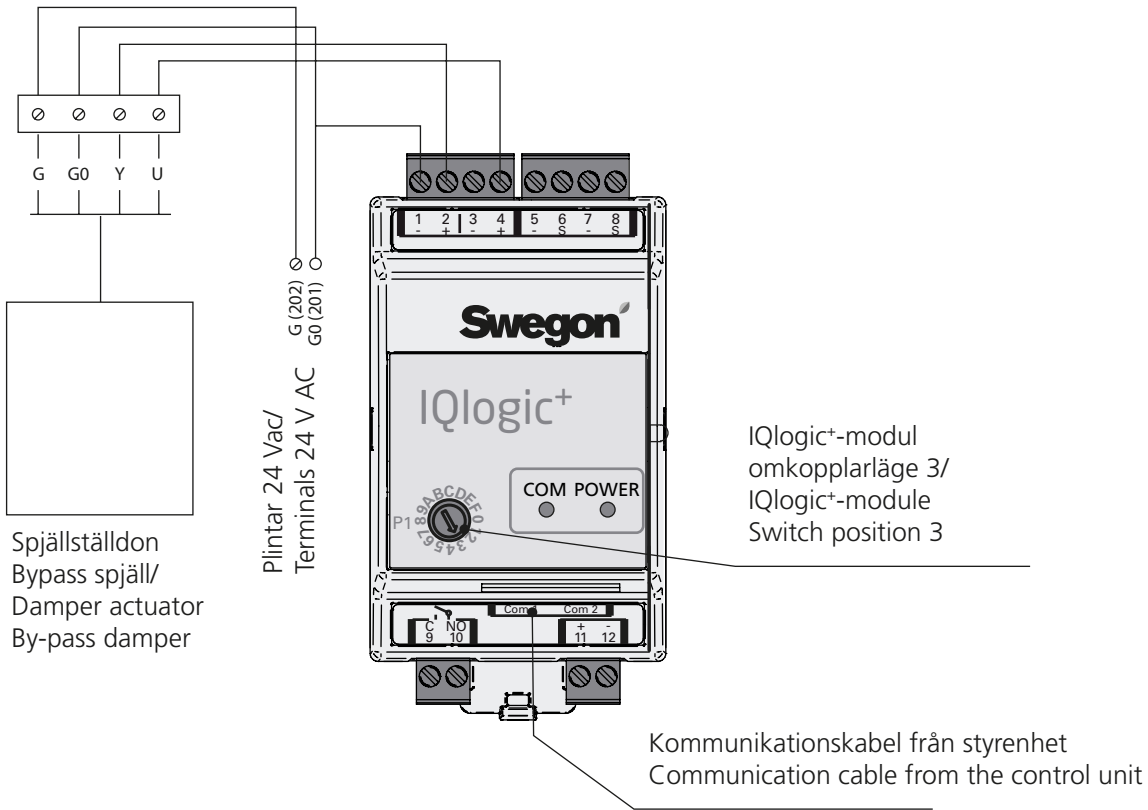

## J: GOLD RX/PX/CX/SD 04-40

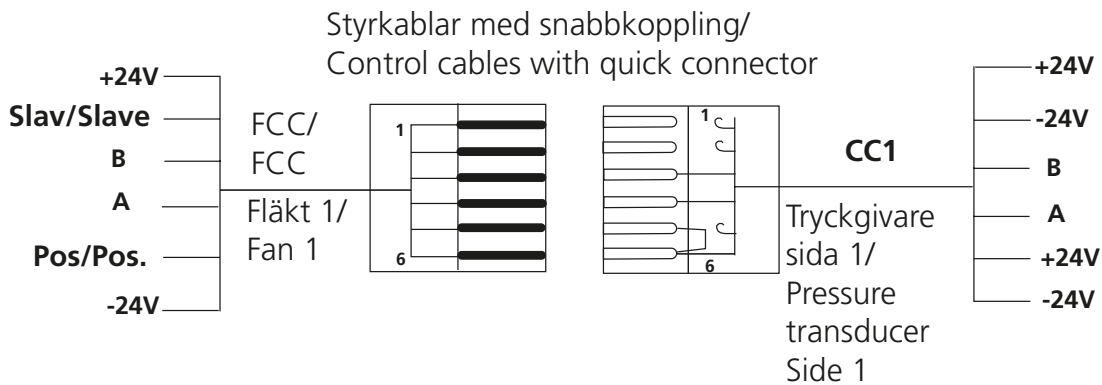

## K: GOLD RX/PX/CX/SD 04-40

